

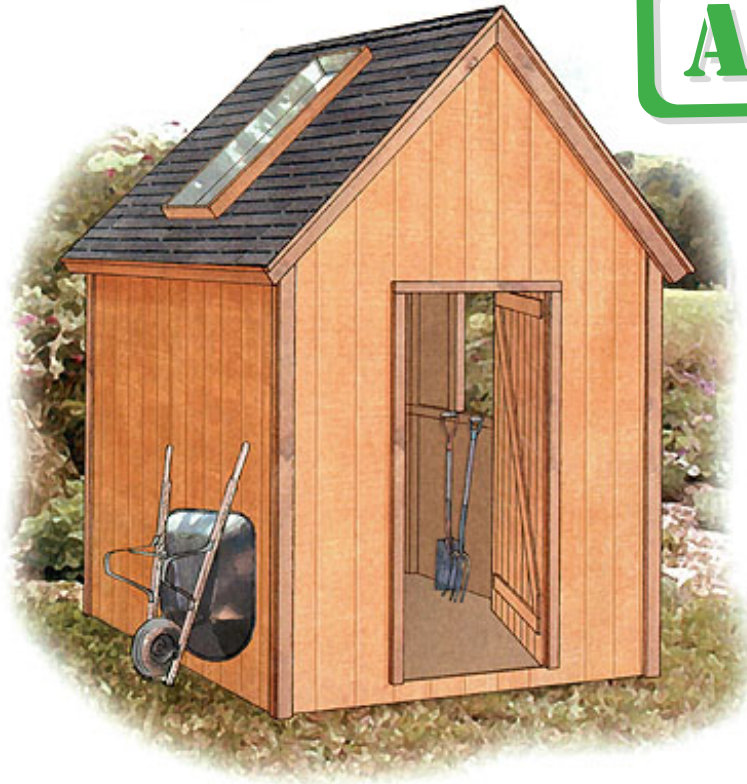

Timber-frame Garden Shed

[▶ Add to My Projects](#)

[HOME](#)
[PRODUCT GUIDE](#)
[TOOL SCHOOL](#)
[▶ HOW-TO CENTER](#)
[PEOPLE & EVENTS](#)
[CUSTOMER SERVICE](#)
[STORE LOCATOR](#)
[GIFT REGISTRY](#)



APPROVED

Timber-framing is a traditional building method that uses a simple framework of heavy timber posts and beams connected with hand-carved joints. From the outside, a timber-frame building looks like a standard, stick-framed structure, but the stout, rough-sawn members give the interior the feel of an 18th-century barn or workshop.

This 8 × 10-ft. shed has the same rough-sawn timbers and basic design used in traditional timber-framing, but with joints that are easy to make. In addition to an attractive interior, the shed has a homemade skylight and a large side window that make it a bright, inviting space. If staying cool is a concern, install operable windows, or adapt the shed frame to add more windows. Adding roof vents can improve ventilation, as well.

The roof frame in this project is made with standard 2 × 4s, but if you're willing to pay a little more to improve the appearance, you can use rough-cut 2 × 4s or 4 × 4s for the roof framing.

Materials		
Description	Quantity/Size	Material
Foundation		
Drainage material	25 cu. ft.	Compactible gravel
Skids	3 @ 10'-0"	4 × 4 treated timbers
Floor Framing		
Rim joists	2 @ 10'-0"	2 × 6 pressure-treated
Joists	9 @ 8'-0"	2 × 6 pressure-treated
Joist clip angles	18	3 × 3 × 3" × 18-gauge galvanized
Floor sheathing	3 sheets 4 × 8'	3/4" tongue-&-groove ext.-grade plywood
Wall Framing		
Posts	6 @ 8'-0"	4 × 4 rough-sawn cedar
Window posts	2 @ 4'-0"	4 × 4 rough-sawn cedar
Girts	2 @ 10'-0", 2 @ 8'-0"	4 × 4 rough-sawn cedar
Beams	2 @ 10'-0", 2 @ 8'-0"	4 × 6 rough-sawn cedar
Braces	8 @ 2'-0"	4 × 4 rough-sawn cedar
Post bases	6, with nails	Simpson BC40
Post-beam connectors	8 pieces, with nails	Simpson LCE
L-connectors	4, with nails	Simpson A34
Roof Framing		
Rafters	12 @ 7'-0"	2 × 4
Collar ties	1 @ 10'-0"	2 × 4
Ridge board	1 @ 10'-0"	2 × 6
Metal anchors-rafters	8, with nails	Simpson H1

Gable-end blocking	4 @ 7'-0"	2 × 2
Exterior Finishes		
Siding	2 @ 14'-0", 8 @ 12'-0", 10 @ 10'-0", 29 @ 9'-0"	1 × 8 T&G V-joint rough-sawn cedar
Corner trim	8 @ 9'-0"	1 × 4 rough-sawn cedar
Fascia	4 @ 7'-0", 2 @ 12'-0"	1 × 6 rough-sawn cedar
Fascia trim	4 @ 7'-0", 2 @ 12'-0"	1 × 2 rough-sawn cedar
Subfascia	2 @ 12'-0"	1 × 4 pine
Plywood soffits	1 sheet 4 × 8'	3/4" cedar or fir plywood
Soffit vents	4 @ 4 × 12"	Louver with bug screen
Flashing (door)	4 linear ft.	Galvanized—18 gauge
Roofing		
Roof sheathing	6 sheets 4 × 8'	1/2" ext.-grade plywood
Asphalt shingles	1.7 squares	250# per square (min.)
15# building paper	140 sq. ft.	
Metal drip edge	2 @ 12'-0", 4 @ 7'-0"	Galvanized metal
Roof vents (optional)	2 units	
Roofing cement	1 tube	
Skylight		
Frame	1 @ 12'-0"	2 × 8
Glazing tape	24 linear ft.	
Stops	1 @ 12'-0"	1 × 2 clear redwood
Glass	1 piece—field measure	5/16' tempered, clear (Optional: 1/4" plexiglass, clear)
Flashing	14 linear ft.	Prefinished metal-24 gauge

Window		
Frame	4 @ 6'-0"	3/4 × 4 1/4" (actual) S4S cedar
Mullion	1 @ 4'-0"	2 × 4 S4S cedar
Stops	8 @ 6'-0"	1 × 2 S4S cedar
Glazing tape	44 linear ft.	Glazing tape
Glass	2 pieces-field measure	1/4" tempered, clear
Trim	4 @ 6'-0", 4 @ 4'-0"	1 × 3 rough-sawn cedar
Door		
Frame	2 @ 7'-0", 1 @ 4'-0"	3/4 × 4 1/4" (actual) S4S cedar
Stops	2 @ 7'-0", 1 @ 4'-0"	1 × 2 S4S cedar
Panel material	7 @ 7'-0"	1 × 6 T&G V-joint rough-sawn cedar
Z-brace	2 @ 6'-0", 1 @ 8'-0"	1 × 6 rough-sawn cedar
Strap hinges	3	
Trim	5 @ 7'-0'	1 × 3 rough-sawn cedar
Fasteners		
60d common nails	16 nails	
20d common nails	32 nails	
16d galvanized common nails	3 1/2 lbs.	
10d common nails	1 lb.	
10d galvanized casing nails	1/2 lb.	
8d galvanized box nails	1 1/2 lbs.	

8d galvanized finish nails	7 lbs.
8d box nails	1/4 lb.
6d galvanized finish nails	40 nails
3d galvanized finish nails	50 nails
1 1/2" joist hanger nails	72 nails
2 1/2" deck screws	25 screws
1 1/2" wood screws	50 screws
7/8" galvanized roofing nails	2 lbs.
3/8" x 6" lag screws	16 screws
Silicone-latex caulk	2 tubes
Construction adhesive	4 tubes

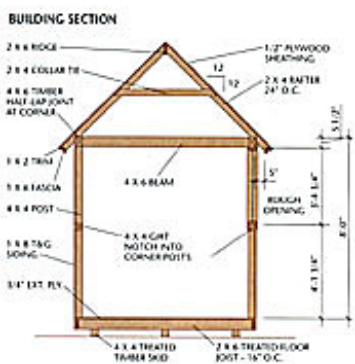
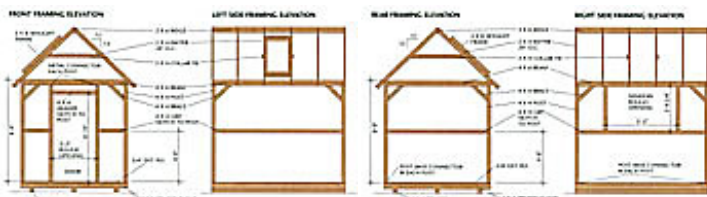

RAFTER TEMPLATE

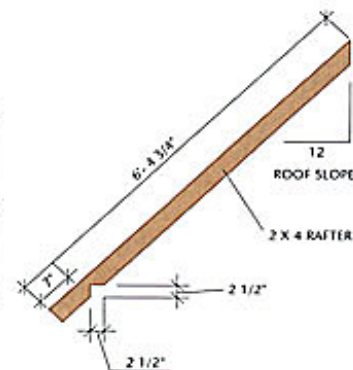

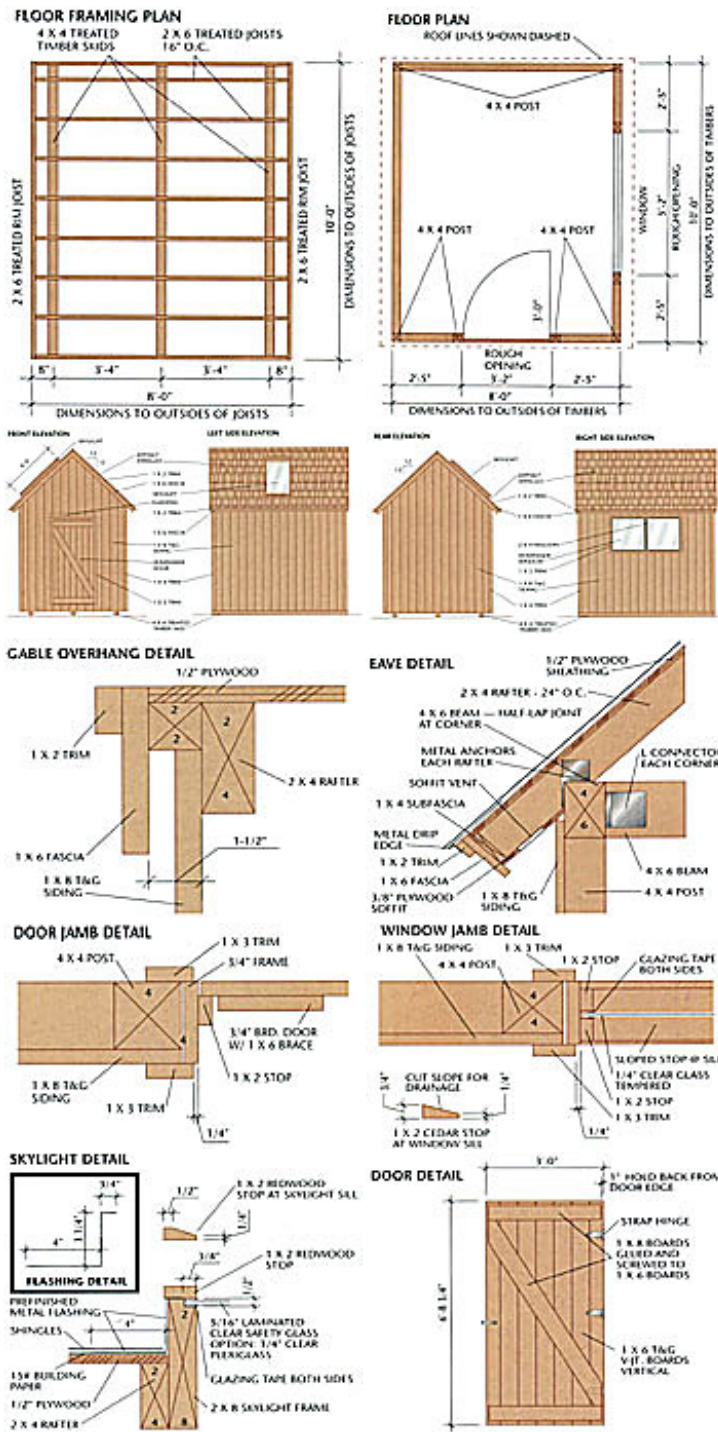

Next Steps and Related Projects:



[Terms and Conditions](#) | [Privacy Policy](#)

Copyright © 2000 - 2002
The Black & Decker Corporation.
All Rights Reserved. Orange and Black is a
trademark of The Black & Decker Corporation.



[Home Product](#)
[Guide How-To](#)
[Center Customer](#)
[Service Store Locator](#)

WELCOME TO



PROJECT CENTER

Experience all that you can do with detailed, step-by-step instructions for projects in and around your home. These informative segments feature the types of challenges you may be faced with either daily or seasonally. Check in with us regularly to see what's new!

Want To Learn More?
 Visit Us At

howtobookstore.com

[click here for Black & Decker Home Improvement books](#)

► Projects & Repairs

Want to do-it-yourself? With hundreds of instructional segments to choose from, here you can find information on home improvement ideas ranging from general repairs and projects for those just getting started to remodeling your bath or kitchen.



► Kitchens, Baths & Floors

Want to have a cozy, elegant home or perhaps you enjoy a modern look and feel? From the kitchen to the bathroom, learn how to remodel yourself. We have the tools and the know-how to help you get started.



► Five Projects for your New Home

All home improvements are not created equally. Many projects will give you a high return on investment while some will just drain your wallet. We will continually update this section with projects to efficiently increase the resale value of your home.



► Tool Tips

Information on how to best put your Black & Decker tools to work for you.



PRODUCT GUIDE

- [Home](#) [Product](#)
- [Guide](#) [Power](#)
- [Tools](#) [Outdoor](#)
- [Equipment](#) [Cleaning](#)
- [Products](#) [Accessories](#) [New](#)
- [Products](#) [How-To](#)
- [Center](#) [Customer](#)
- [Service](#) [Store Locator](#)



[Terms and Conditions](#) | [Privacy Policy](#)

Copyright © 2000 - 2004
The Black & Decker Corporation.

All Rights Reserved. Orange and Black is a trademark of The Black & Decker Corporation.



POWER TOOLS CATALOG

Two Easy Ways To Search:

1. Search Product

Type

[Glossary](#)

2. Search by Brand



High Performance
Cordless Tools



Sander & Polisher



Two Position Cordless
Screwdriver



High Performance Rotary
Tool



3-In-1 Sander



Rechargeable Flexible
Flashlight



Interchangeable Battery
System



Portable Project Center
& Vise



Powered Hand Saw/Jig
Saw



Multi-Project Tool



5 Position Drill Driver



High Performance
Sander & Polisher



Laser Level and Stud
Finder



POWER TOOLS CATALOG

Two Easy Ways To Search:

1. Search Product

Type

[Glossary](#)

2. Search by Brand

[Brand Glossary](#)

 High
Performance Drill Bits

 High
Performance Cordless
Vac

 Lawn
Edger

 High
Performance Cordless
Tools

Cordless Room Vac

 String
Trimmers

 Hedge
Trimmer

 Sander
& Polisher

 Drilling
& Driving System

 High
Performance Rotary Tool

Cordless Wet Scrubber

Interchangeable Battery
System

Workmate®

Portable Project Center
& Vise

[Terms and Conditions](#) | [Privacy Policy](#)

Copyright © 2000 - 2004

[The Black & Decker Corporation.](#)

All Rights Reserved. Orange and Black is a trademark of The Black & Decker Corporation.



POWER TOOLS CATALOG

Two Easy Ways To Search:

1. Search Product

Type

[Glossary](#)

2. Search by Brand

[Brand Glossary](#)

 High
Performance Drill Bits

 High
Performance Cordless
Vac

 Lawn
Edger

 High
Performance Cordless
Tools

Cordless Room Vac

 String
Trimmers

 Hedge
Trimmer

 Sander
& Polisher

 Drilling
& Driving System

 High
Performance Rotary Tool

Cordless Wet Scrubber

Interchangeable Battery
System

Workmate®

Portable Project Center
& Vise

[JOIN NOW](#) - E-Mail

Password

[Go](#)

[Password](#)

[Reminder](#)



CLEANING PRODUCTS CATALOG

Two Easy Ways To Search:

1. Search Product

Type

[Glossary](#)

2. Search by Brand



High Performance
Cordless Vac



Cordless Room Vac



Cordless Wet Scrubber



Corded Stick Vac



Hand Steam and Wet/
Dry Vac

[Terms and Conditions](#) | [Privacy Policy](#)

Copyright © 2000 - 2004

The Black & Decker Corporation.

All Rights Reserved. Orange and Black is a trademark of The Black & Decker Corporation.

[JOIN NOW](#) - E-Mail

Password

[Go](#)

[Password](#)

[Reminder](#)



OUTDOOR POWER EQUIPMENT CATALOG

Two Easy Ways To Search:

1. Search Product

Type

[Glossary](#)

2. Search by Brand



Lawn Edger



String Trimmers



Hedge Trimmer



Electric Mulching Mowers



Blower/Vacuum



Sprayer

[Terms and Conditions](#) | [Privacy Policy](#)

Copyright © 2000 - 2004

[The Black & Decker Corporation.](#)

All Rights Reserved. Orange and Black is a trademark of The Black & Decker Corporation.



POWER TOOLS CATALOG

Two Easy Ways To Search:

1. Search Product

Type

[Glossary](#)

2. Search by Brand



High Performance
Cordless Tools



Sander & Polisher



Two Position Cordless
Screwdriver



High Performance Rotary
Tool



3-In-1 Sander



Rechargeable Flexible
Flashlight



Interchangeable Battery
System



Portable Project Center
& Vise



Powered Hand Saw/Jig
Saw



Multi-Project Tool



5 Position Drill Driver



High Performance
Sander & Polisher



Laser Level and Stud
Finder



CUSTOMER SERVICE

Need Help with a Product?

▶ [Frequently asked Questions \(FAQs\)](#)

Do you have a question about your tool or product? Check here first to find the answers.

▶ [Contest Winners](#)

A listing of contest winners and related prizes.

▶ [Service Center Locator](#)

Find one of our 450 conveniently located service centers across North America.

▶ [Recall Announcements](#)

Black & Decker is committed to safety, look here for important announcements



Other Helpful Links

- ▶ [Product Registration](#)
- ▶ [Submitting Inventions](#)
- ▶ [Site Help](#)

Home Product
Guide How-To
Center Customer
Service [Service](#)
[Centers](#) [FAQ's](#) [Product](#)
[Registration](#) [Contact](#)
[Us](#) [Product Ideas](#) [Store](#)
Locator

Contact Us



Reach Us By Email

To help us effectively process your customer service inquiry, Please choose one of the product categories below:



Power Tools
Cleaning Products
Outdoor Equipment



Beverage
Food Preparation
Garment Care

Phone:

(800) 544-6986

Consumer Service is available Monday-Friday
8:00 a.m. - 5:00 p.m. Eastern Standard Time

Address:

Consumer Service Center
Black & Decker
626 Hanover Pike
Hampstead, MD 21074 USA

Shopping Suggestions

Pricing

As a manufacturer, Black & Decker does not determine retail pricing. Due to the competitive nature of our industry, prices for products may vary from store to store, since each retailer is free to determine the price of the products they sell. Please check your local store for pricing details.



[Terms and Conditions](#) | [Privacy Policy](#)

Copyright © 2000 - 2004

The Black & Decker Corporation.

All Rights Reserved. Orange and Black is a trademark of The Black & Decker Corporation.

[JOIN NOW](#) - E-Mail

Password

[Go](#)

[Password](#)

[Reminder](#)



STORE LOCATOR

[Home](#) [Product](#)
[Guide](#) [How-To](#)
[Center](#) [Customer](#)
[Service](#) [Store Locator](#)

Shop for Black & Decker products in two easy steps.

Where are you interested in shopping?

[Terms and Conditions](#) | [Privacy Policy](#)

Copyright © 2000 - 2004

The Black & Decker Corporation.

All Rights Reserved. Orange and Black is a trademark of The Black & Decker Corporation.



[Home](#) [Product Guide](#) [How-To Center](#) [Customer Service](#) [Store Locator](#)



◀ **Featured Product**
18Volt Lawncare Center



BLACK & DECKER
BEAT | BOOMER

Think you can Beat Boomer?
Enter your weekly NFL picks. Compete EVERY week for a trip to Hawaii, \$1,000 in B&D Power Tools, and more!
[Click Here to Play and Earn a \\$5 B&D Laser Rebate.](#)

[Terms and Conditions](#) | [Privacy Policy](#)

Copyright © 2000 - 2004
The Black & Decker Corporation.
All Rights Reserved. Orange and Black is a trademark of The Black & Decker Corporation.



Fields marked with an asterisk are required:

- [Home Product](#)
- [Guide How-To](#)
- [Center Customer](#)
- [Service Store Locator](#)

***Please select a Password** ***Please retype Password**

***Prefix**

Mr. Ms Mrs. Miss

***First Name**

***Last Name**

***Email Address**

This will be your BlackAndDecker.com User ID

Street Address

***City**

***State/Province**

***Zip/Postal Code**

***Country**

Phone

***Would you like to receive email notifications from Black & Decker ?**

yes no

[JOIN NOW](#) - E-Mail

Password

[Go](#)

[Password](#)

[Reminder](#)



Password must be at least six characters. Please select a prefix. Please enter your first name. Please enter your last name. Please enter a valid email address. Please enter a valid city. Please enter a valid post code. Please enter a valid country. Please select an Email preference.

- [Home Product](#)
- [Guide How-To](#)
- [Center Customer](#)
- [Service Store Locator](#)

- * Prefix
- * First Name
- * Last Name
- * Email
- Street
- * City
- State
- * Zip/Postal Code
- * Country
- Phone
- * Want to receive Email

Alabama

[Terms and Conditions](#) | [Privacy Policy](#)

Copyright © 2000 - 2004

The Black & Decker Corporation.

All Rights Reserved. Orange and Black is a trademark of The Black & Decker Corporation.



[Home Product](#)
[Guide How-To](#)
[Center Customer](#)
[Service Store Locator](#)

WELCOME TO



PROJECT CENTER

Experience all that you can do with detailed, step-by-step instructions for projects in and around your home. These informative segments feature the types of challenges you may be faced with either daily or seasonally. Check in with us regularly to see what's new!

Want To Learn More?
 Visit Us At

howtobookstore.com

[click here for Black & Decker Home Improvement books](#)

▶ Projects & Repairs

Want to do-it-yourself? With hundreds of instructional segments to choose from, here you can find information on home improvement ideas ranging from general repairs and projects for those just getting started to remodeling your bath or kitchen.



▶ Kitchens, Baths & Floors

Want to have a cozy, elegant home or perhaps you enjoy a modern look and feel? From the kitchen to the bathroom, learn how to remodel yourself. We have the tools and the know-how to help you get started.



▶ Five Projects for your New Home

All home improvements are not created equally. Many projects will give you a high return on investment while some will just drain your wallet. We will continually update this section with projects to efficiently increase the resale value of your home.



▶ Tool Tips

Information on how to best put your Black & Decker tools to work for you.

[JOIN NOW](#) - E-Mail

Password

[Go](#)

[Password](#)

[Reminder](#)



Home Improvement

[Home Product](#)

[Guide How-To](#)

[Center Customer](#)

[Service Store Locator](#)



[Terms and Conditions](#) | [Privacy Policy](#)

Copyright © 2000 - 2004

The Black & Decker Corporation.

All Rights Reserved. Orange and Black is a trademark of The Black & Decker Corporation.

[JOIN NOW](#) - E-Mail

Password

[Go](#)

[Password](#)

[Reminder](#)



New Remodeling Projects

[Home Product](#)

[Guide How-To](#)

[Center Customer](#)

[Service Store Locator](#)



[Terms and Conditions](#) | [Privacy Policy](#)

Copyright © 2000 - 2004

[The Black & Decker Corporation.](#)

All Rights Reserved. Orange and Black is a trademark of The Black & Decker Corporation.



[Home Product](#)
[Guide How-To](#)
[Center Customer](#)
[Service Store Locator](#)

Black & Decker offers up these **Five Projects** to increase the value of your new home.



Kitchen Plumbing

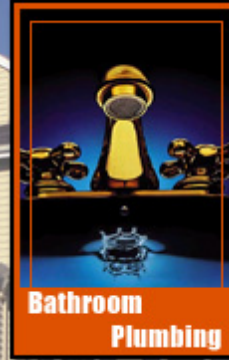

Bathroom Plumbing



Lighting Basics



Finishing touches

**Click on a project
and learn how you can
do-it-yourself.**



Bathroom Flooring

[Terms and Conditions](#) | [Privacy Policy](#)

Copyright © 2000 - 2004

The Black & Decker Corporation.

All Rights Reserved. Orange and Black is a trademark of The Black & Decker Corporation.



Making Finishing Touches

[Home Product](#)
[Guide How-To](#)
[Center Customer](#)
[Service Store Locator](#)



Fill bathtubs and whirlpools at least half full of water before caulking around the edges to approximate the full tub weight. Tubs shift position when filled with water; caulking when the tub is full helps ensure that the caulking seal does not stretch and pull apart when the tub is filled.

Hanging towel rods, mirrors, and other accessories, caulking seams, and sealing tile and grout are a few of the small projects that bring your bathroom remodeling project to completion.

Whenever possible, anchor accessories to wall studs or blocking for maximum holding power. If no studs or blocking are located in the area where accessories will be installed, use special fasteners, like toggle bolts or molly bolts, to anchor the accessories to wallboard or plaster walls.

Use tub & tile caulk for most bathroom sealing projects. Most tub & tile caulk is a blend of silicone and latex that offers the best features of both. Pure silicone expands and contracts with fixtures, like bathtubs, that can shift position. It is a long-lasting, effective sealant, but it is relatively expensive and cannot be painted.

Latex caulk is inexpensive and it holds paint well. It also is easy to apply in smooth, neat beads, but it breaks down more quickly than silicone, and it can trap odors and mildew. Some tub & tile caulk contains acrylic for a hard surface. Caulk of all types should be inspected yearly, and reapplied as needed.

Everything You Need:

Tools:

tape measure
jig saw with metal-cutting
blade or hacksaw
drill
caulk gun
groutfloat

Materials:

caulk
screws
sleeves and anchors
tape

Options for Attaching Bathroom Accessories

Attach accessories and hardware between wall studs by using screw sleeves or special fasteners that are attached directly to the wall surface. Plastic anchor sleeves (A), often used in ceramic tile, are inserted into pilot holes, where they expand when screws are driven. Grip-it® fasteners (B), molly bolts (C), and toggle bolts (D) provide more holding power than sleeves.

Next Steps and Related Projects:



[Terms and Conditions](#) | [Privacy Policy](#)

Copyright © 2000 - 2004

The Black & Decker Corporation.

All Rights Reserved. Orange and Black is a trademark of The Black & Decker Corporation.



Plumbing a Kitchen

Home Product
Guide How-To
Center Customer
Service Store Locator

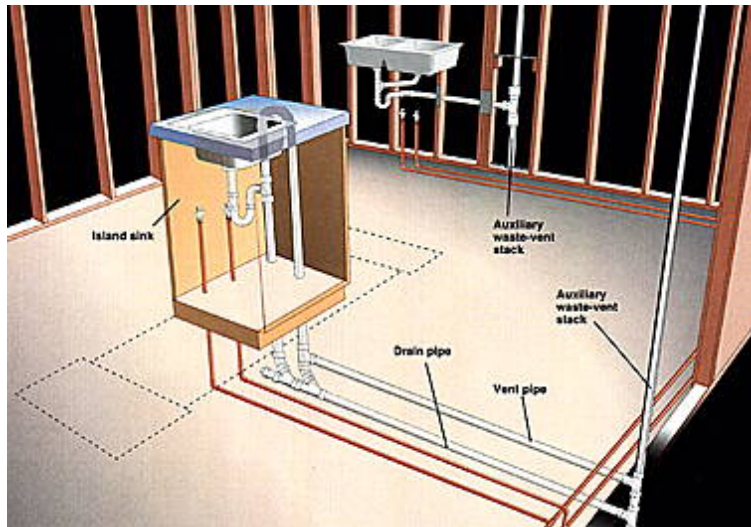

Plumbing a remodeled kitchen is a relatively easy job if your kitchen includes only a wall sink. If your project includes an island sink, however, the work becomes more complicated.

An island sink poses problems because there is no adjacent wall in which to run a vent pipe. For an island sink, you will need to use a special plumbing configuration known as a *loop vent*.

Each loop vent situation is different, and your configuration will depend on the location of existing waste-vent stacks, the direction of the floor joists, and the size and location of your sink base cabinet. Consult your local plumbing inspector for help in laying out the loop vent.

Our demonstration kitchen includes a double wall sink and an island sink. The 1 1/2" drain for the wall sink connects to an existing 2" galvanized waste-vent stack; since the trap is within 3 1/2 ft. of the stack, no vent pipe is required. The drain for the island sink uses a loop vent configuration connected to an auxiliary waste-vent stack in the basement.

The following information shows plumbing methods specific to a kitchen project. If you are not familiar with basic plumbing methods, find a good reference book to help you with this work.

Everything You Need:

Tools:

wire brush
drill with wire wheel
attachment
cold chisel
hand maul
paint brush
trowel

Materials:

vinyl-reinforced patching
compound
concrete caulk
sand-mix concrete

Next Steps and Related Projects:



[Terms and Conditions](#) | [Privacy Policy](#)

Copyright © 2000 - 2004

The Black & Decker Corporation.

All Rights Reserved. Orange and Black is a trademark of The Black & Decker Corporation.



General Repairs - Plumbing

[Home Product](#)

>

>

[Guide How-To](#)

[Center Customer](#)

[Service Store Locator](#)



•

•

•

•



[Terms and Conditions](#) | [Privacy Policy](#)

Copyright © 2000 - 2004
The Black & Decker Corporation.
All Rights Reserved. Orange and Black is a trademark of The Black & Decker Corporation.



Installing Electrical Fixtures

[Home Product](#)
[Guide How-To](#)
[Center Customer](#)
[Service Store Locator](#)

>

>

>

Running cables for new electrical fixtures is easiest if wall surfaces have been removed. Make the final wiring hookups at the fixtures after wall surfaces are finished.

Follow Local Code requirements for wiring bathrooms. Reduce shock hazard by protecting the entire bathroom circuit with GFCI receptacles. Install only electrical fixtures that are U.L. - approved.

If it is not practical to remove wall surfaces, "retrofit" techniques can be used to install vent fans and other fixtures. Most wiring connections for bathroom fixtures are easy to make, but wiring configurations in electrical boxes vary widely, depending on the type of fixture and the circuit layout.

If you are not confident in your skills, have an electrician install and connect fixtures. Unless you are very experienced, leave the job of making circuit connections at the main service panel to an electrician.

Everything You Need:

Tools:

neon circuit tester
wire stripper
cable ripper
screwdriver
level

Materials:

NM cable
wire staples
wire nuts
screws

Safety Issues:

Always shut off electrical power at the main service panel, and test for power before working with wires.

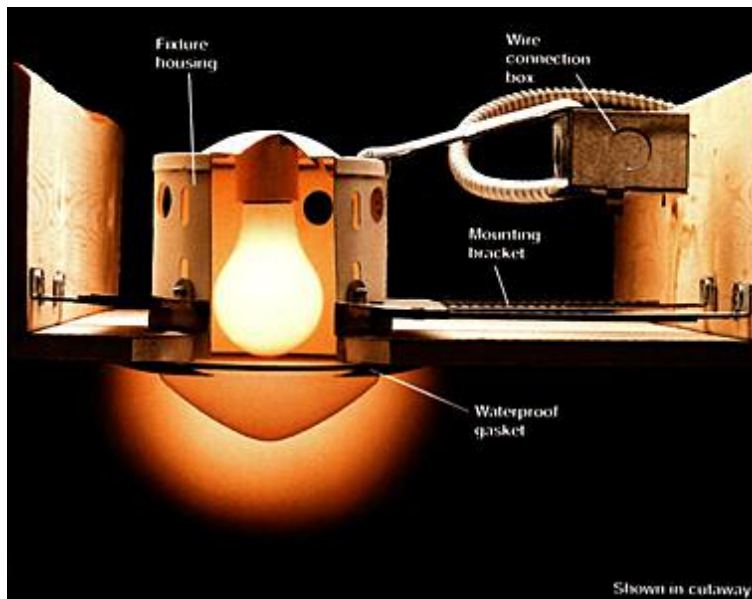

Installing most bathroom lights is similar to installing lights in any other room in the house. Adding new lighting fixtures makes a bathroom safer and more inviting, and can even make bathrooms seem larger. In showers, install only vaporproof lights that have been U.L. rated for wet areas. Shower lights have a waterproof gasket that fits between the fixture and the light cover.

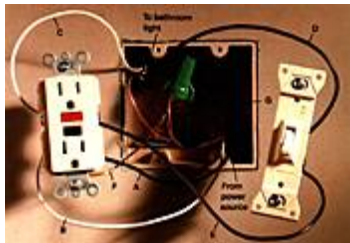

Install a GFCI receptacle and switch by making the following connections: black wire from power source (A) to brass screw marked LINE on GFCI; white wire from power source (B) to silver screw marked LINE; white wire to light (C) to silver GFCI screw marked LOAD; black wire to light (D) to a screw terminal on switch. Cut a short length of black wire (E), and attach one end to brass GFCI screw marked LOAD, and other end to a screw terminal on switch. Connect a bare grounding pigtail wire to GFCI grounding screw (F), and join all bare grounding wires (G) with a wire nut. Tuck wires into box, then attach switch, receptacle, and coverplate.

Next Steps and Related Projects:



[Terms and Conditions](#) | [Privacy Policy](#)

Copyright © 2000 - 2004
The Black & Decker Corporation.

All Rights Reserved. Orange and Black is a trademark of The Black & Decker Corporation.



Repairing Ceramic Tile Floors

[Home Product](#)[Guide How-To](#)[Center Customer](#)[Service Store Locator](#)

Apply grout sealer to grout joints every 1-2 years to protect against water, wear, and stains. Use a sponge brush to spread the sealer and keep it off the tiles. Allow new grout to cure fully before sealing it.

Like the tile on your bathroom or kitchen walls, floor tile must be watertight. All the grout lines must be solid and full, and every tile must be free of cracks or chips. Neglecting problems can result in damage to the underlayment and subfloor, and possibly to the entire tile job.

Perhaps the greatest challenge with tile repair is matching the grout color. If you're regrouting an entire floor, just select a color that compliments the tile; if you're replacing a tile, you have to blend the new grout with the old. A good tile dealer can help you get the best color match.

Floor tile is typically bonded to the floor with a cement-based adhesive, known as *thin-set mortar*. If you find another adhesive, such as mastic, under the original tile, use the same type to install replacement tiles.

Everything You Need:

Tools:

Sponge brush
utility knife
grout saw or rotary tool
cold chisel
hammer
putty knife
notched trowel
rubber mallet
screwdriver
rounded sponge
rubber grout float

Materials:

Grout sealer
thin-set mortar
2 x 4
carpet
grout

Next Steps and Related Projects:



[Terms and Conditions](#) | [Privacy Policy](#)

Copyright © 2000 - 2004

The Black & Decker Corporation.

All Rights Reserved. Orange and Black is a trademark of The Black & Decker Corporation.

[JOIN NOW](#) - E-Mail

Password

[Go](#)

[Password](#)

[Reminder](#)



Home Improvement

[Home Product](#)

[Guide How-To](#)

[Center Customer](#)

[Service Store Locator](#)



[Terms and Conditions](#) | [Privacy Policy](#)

Copyright © 2000 - 2004
[The Black & Decker Corporation.](#)

All Rights Reserved. Orange and Black is a trademark of The Black & Decker Corporation.



PRODUCT GUIDE

- [Home](#) [Product](#)
- [Guide](#) [Power](#)
- [Tools](#) [Outdoor](#)
- [Equipment](#) [Cleaning](#)
- [Products](#) [Accessories](#) [New](#)
- [Products](#) [How-To](#)
- [Center](#) [Customer](#)
- [Service](#) [Store Locator](#)



[Terms and Conditions](#) | [Privacy Policy](#)

Copyright © 2000 - 2004
The Black & Decker Corporation.

All Rights Reserved. Orange and Black is a trademark of The Black & Decker Corporation.

[JOIN NOW](#) - E-Mail

Password

[Go](#)

[Password](#)

[Reminder](#)



CLEANING PRODUCTS CATALOG

Two Easy Ways To Search:

1. Search Product

Type

[Glossary](#)

2. Search by Brand



High Performance
Cordless Vac



Cordless Room Vac



Cordless Wet Scrubber



Corded Stick Vac



Hand Steam and Wet/
Dry Vac

[Terms and Conditions](#) | [Privacy Policy](#)

Copyright © 2000 - 2004

The Black & Decker Corporation.

All Rights Reserved. Orange and Black is a trademark of The Black & Decker Corporation.

BEAT BOOMER ▶



Win a trip to the 2005 Pro Bowl® in Hawaii. *

Black & Decker challenges you to beat Boomer Esiason at his own game! Register below and place your weekly NFL football picks. You could win 1 of 16 trips to the Pro Bowl® in Hawaii and other great prizes.

Email Address

Password

▶ **Please Log In Here:**
Existing Black & Decker users should use their login information.
▶ **New Users Register Here to Play**

LASER GAME ▶



Play our Virtual Laser Game to 'get it straight the first time' and receive a \$5 rebate on your next B&D Laser purchase.

WHAT'S NEW @ BLACK & DECKER ▶



Power. Performance. Innovation. Here's your 'insider' look at the newest products from Black & Decker

LASER STRAIGHT TALK ▶



Learn more about the Black & Decker laser line of products. Discover ways that the laser products can simplify your projects and save you time.

* Pro Bowl® is a registered trademark of the National Football League. This Promotion is not endorsed by the National Football League.



Answers Ask a Question Your Profile Help

Home Product Guide How-To Center Customer Service Service Centers FAQ's Product Registration Contact Us Product Ideas Store Locator

* Denotes a required field.

Identification

* User ID: (enter email address if you do not have a user ID)

Your Question is...

Subject:

Additional Information

* Category:
Catalog Number:
Type Number:
Daytime Phone: To be used only if we need clarification regarding your email.

Attach Documents to Question

1

When You are Done...



beverage | cooking | food preparation | garment care | SpaceMaker™ | home comfort | pest control

Home

What's New

Products

Shop Online

Use and Care

FAQ's

Recipes

Registration &
Warranty

Retailers &
Other Links

Contact Us

Press Room

Site Map

Safety Recall
Info

See Other
Brands from
Applica

Enter
Latin
American
Site

Contact Us - Step 1

To better help us direct your email to the appropriate department please select one of the following below based on your question(s):

Order Info Kitchen, Garment Care, Home Environment	Parts Info	Product Info Kitchen, Garment Care, Home Environment	Product Info Power Tools, Cleaning, Outdoor Equipment	Warranty Info	Web Site Issue
Order questions regarding Kitchen Appliance, Garment Care, or Home Environment product(s).	Questions regarding where to find replacement parts for your product(s).	Product questions regarding Kitchen Appliance, Garment Care, or Home Environment product(s).	Product questions regarding Power Tools, Cleaning, or Outdoor Equipment product(s).	Questions regarding the warranty of your product(s).	Questions regarding technical problems with this website.

Toll Free Numbers:

Black & Decker Household Products

Product Orders

1-800-743-8625

(Monday -Friday)8:30 AM - 8:00 PM. ET

(Saturday) 9:00 AM - 3:00 PM ET

Parts Orders

1-800-738-0245

Monday - Sunday (8:00am-8:00pm) ET

Product or Warranty Questions

1-800-231-9786

(Monday - Sunday) 8:00 AM - 8:00 PM ET

Black & Decker - Cleaning, Lighting & Powertools

Product or Warranty Questions

1-800-544-6986

(Monday - Saturday) - 8:00AM - 5:00PM, ET

Parts Orders - Cleaning, Lighting & Powertools

1-888-678-7278

(Monday - Friday) - 8:30AM - 4:45PM ET

To find a Factory Store near you, click on the link below:

<http://www.blackanddecker.com/locator/Default.aspx>

[Home](#) | [Beverage](#) | [Cooking](#) | [Garment Care](#) | [Food Preparation](#) | [SpaceMaker](#) |
[Home Comfort](#) | [Pest Control](#) | [Black & Decker](#) | [Applica Incorporated](#) |
[What's New](#) | [Products](#) | [Shop Online](#) | [Use & Care](#) | [FAQ's](#) | [Recipes](#) |
[Product Registration](#) | [Links](#) | [Contact Us](#) | [Press Room](#) | [Site Map](#) |
[Privacy Policy](#) | [Legal Info](#) |



©2003 Applica Consumer Products, Inc.
Web Site Design & Development by: L&P Media